

AL-SHABAAAB



Full name:

Harakat al-Shabaab al-Mujaideen
("The Youth")



Founded:

2006, offshoot of the Union of
Islamic Courts



Goal:

Establish a fundamentalist Islamic
state in Somalia & Horn of Africa

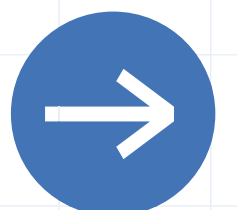



Fighter strength:

7,000-12,000 fighters



Governance & rules:

- ✓ **Enforces extreme Shari'ah law (dress codes, compulsory prayer/study)**
- ✓ **Harsh punishments for violations (stoning, amputation, beheadings)**
- ✓ **Runs parallel government: courts, schools, religious institutes, taxes, basic services.**

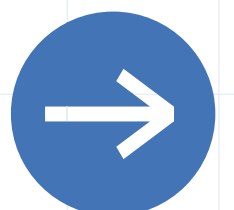
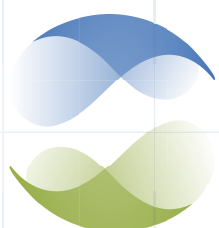

Who Leads Al-Shabaab?

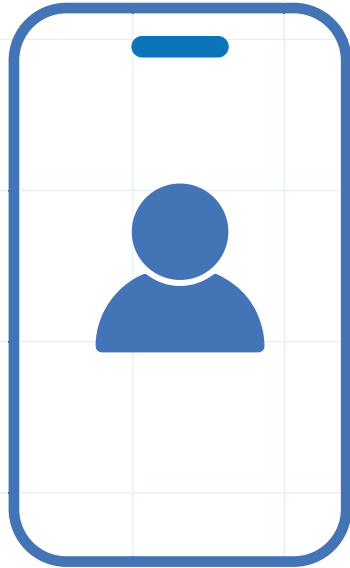

Current Leader:

Ahmed Diriye

(also known as Ahmed Umar Abu Ubaidah)

- ✓ *Installed in 2014*
- ✓ *Took over after the death of his predecessor*



Predecessor:

Ahmed Abdi Godane

- ✓ *Killed in a U.S. drone strike (2014)*

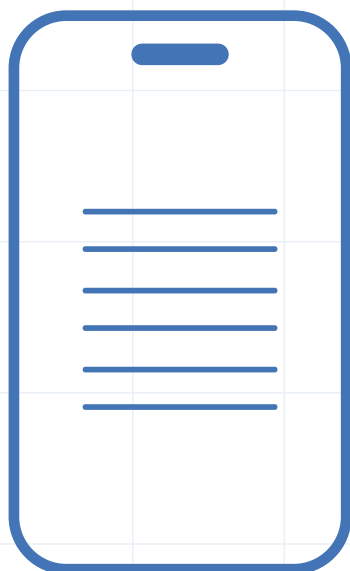

Leadership Structure

- ✓ *Governed by an executive council (Shura)*
- ✓ *Estimated ~12 members*
- ✓ *Main decision-making body*



WORLD ANTI EXTREMISM
NETWORK
BUILDING A FREE WORLD

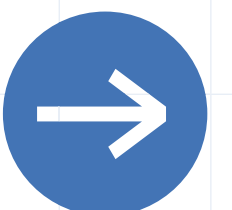

Governance System

- ★ *Established its own local governance and justice mechanisms*

- ★ *Created shadow local administrations called "Wilaayaats."*

- ★ *Each Wilaayaat governs multiple regions (e.g., Wilaayaat Jubooyinka covers Middle Juba and Lower Juba).*

- ★ *Appoints self-styled governors from influential local clans*

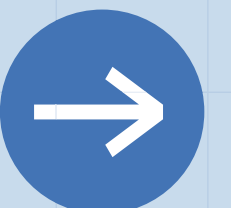
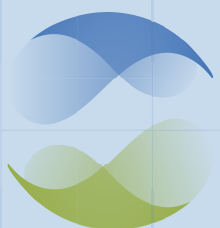

Geographic Control



Strongholds:

Hiraan, Galgaduud, Southern Somalia



Key routes:

Controlled across **South-Central Somalia**



Northern footholds:

Western Al-Madow mountains,
between Bari and Sanaag

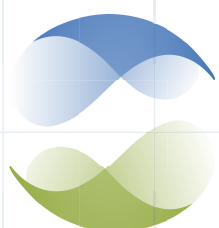

WORLD ANTI EXTREMISM
NETWORK
BUILDING A FREE WORLD

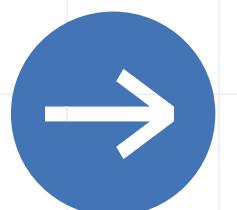

Regional Activity

Kenya: Active in border areas; conducts cross-border attacks.

Ethiopia: Carried out a major incursion in July 2022; involving ~2,000 fighters; ~1,000 reportedly remain.

Uganda: Threatens Ugandan forces deployed to **ATMIS** in Somalia.

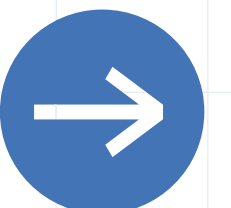

Number of deaths caused

by Al-Shabaab in Somalia from 2017 to 2024

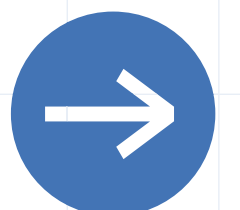
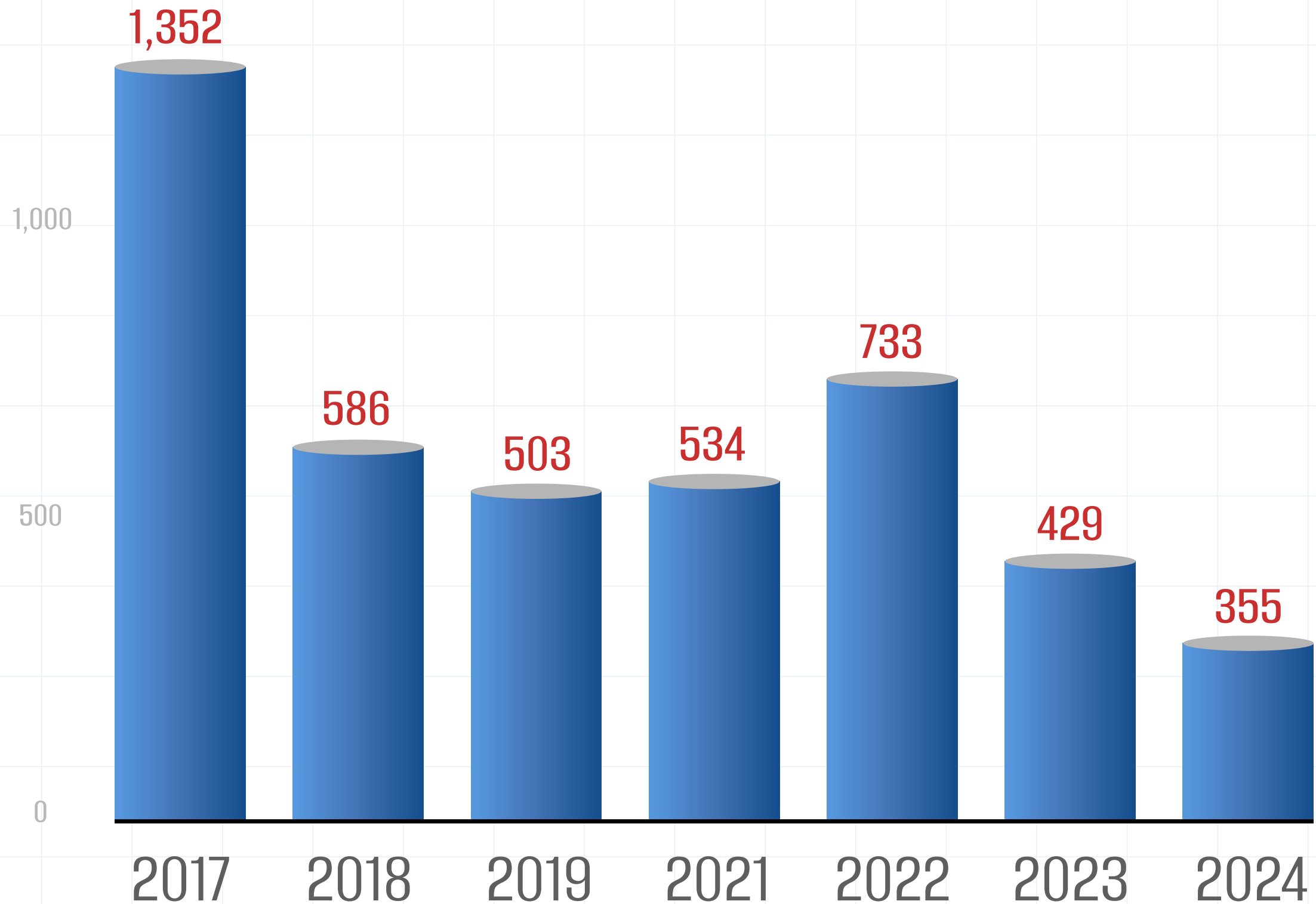



Bombings

57%

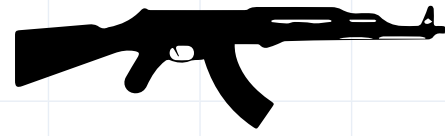

Armed assaults

15%

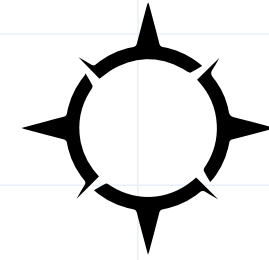

Assassinations

11%

Terrorism Deaths by Attack Type – 2019

Civilian attacks ↓ 13%

But deaths per attack increased

2018: 1.9 deaths per attack

2019: 3.2 deaths per attack

Attacks Became More Deadly



WORLD ANTI EXTREMISM
NETWORK
BUILDING A FREE WORLD

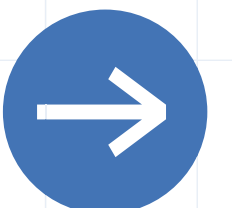

Notable Attacks

by Al-Shabab

Garissa

Garissa University
College attack
148 killed

2015

El Adde

Kenyan AMISOM base
attack
100+ soldiers killed

2016

Mogadishu

truck bombing
500+ killed

2017

Kampala

Kampala suicide
bombings
76 killed

2010

Nairobi

Westgate Mall attack
65 killed

2013



WORLD ANTI EXTREMISM
NETWORK
BUILDING A FREE WORLD

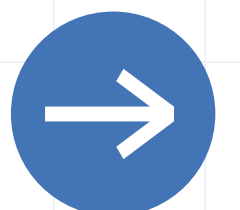

Child Recruitment & Abduction (2022)

900+ recruited
663 abducted

Hotspots:

Bay, Bakool,
Hiraan,
Middle Juba,
Lower Shabelle



WORLD ANTI EXTREMISM
NETWORK
BUILDING A FREE WORLD

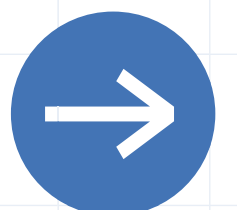

Targets:

- ▲ State governors
- ▲ Election delegates
- ▲ Government officials
- ▲ Clan elders
- ▲ Civilians
- ▲ International aid workers and journalists
- ▲ ATMIS and SNL forces
- ▲ Journalists
- ▲ Human rights activists
- ▲ NGO workers

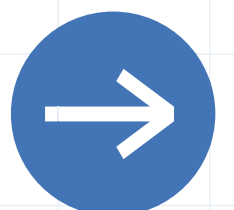

Annual Revenue & Scale

- ✓ Estimated annual revenue:
\$100 million
- ✓ By comparison: Somalia's
federal government revenue
≈ \$250 million
- ✓ Generates revenue from 10 of
Somalia's 18 regions

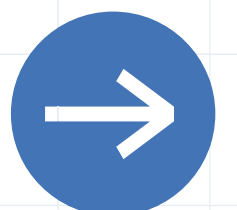

Major Funding Sources

✔ *Collects a 2.5 % annual "zakat" tax from citizens' assets*



✔ *Uses port freight lists to extort shipping companies*

✔ *Attacks main roads to force civilians onto taxed smaller roads*

✔ *Reinvests surplus in land & small/medium businesses*

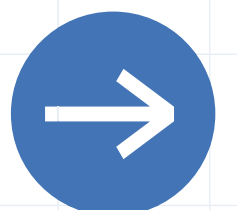

Financial System Use

~155M mobile money transactions/month
(**~\$2.7B**) in Somalia

Al Shabaab exploits weak regulations for
anonymous mobile transfers

2019: banks flagged **9** suspicious, **113** large
cash transactions

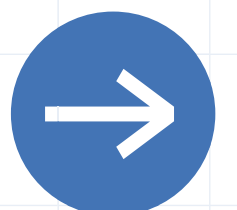

Taxes & Fees

- *Trucks taxed \$555–\$1,150 per trip*
- *Farm produce taxed 10%*
- *Tractor operating license: \$750*
- *Water well rig registration: \$3,000*
- *Vehicle registration: \$200*
- *Piracy & Kidnap-for-Ransom: Taxes 15–20% of pirate ransoms; also profits from inland kidnappings.*

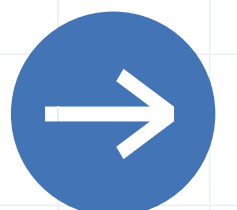

Other Revenue Streams

- *Diaspora support, external assistance, "jihad contributions" (including al-Qaeda)*
- *Diverted international aid & NGO taxation*
- *Drugs & weapons: cocaine, heroin, khat, firearms*
- *Charcoal Revenue: ~\$25M annually (2014); ~\$2 tax per bag*

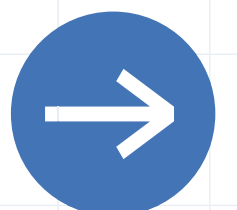

Weapons & Equipment

Small Arms:

AK-47 rifles



PK machine guns



Makarov pistols



Sniper rifles

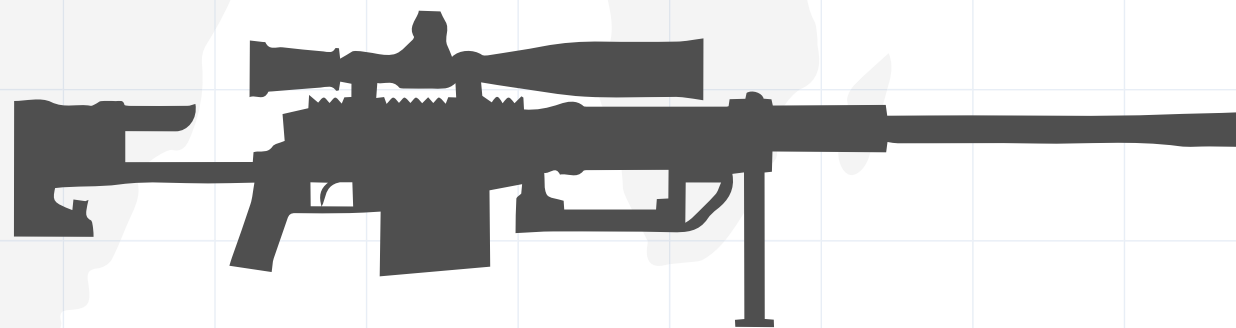

WORLD ANTI EXTREMISM
NETWORK
BUILDING A FREE WORLD

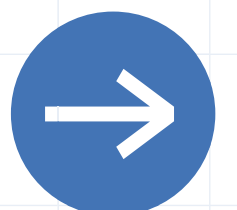

Heavy Weapons:

Grenades

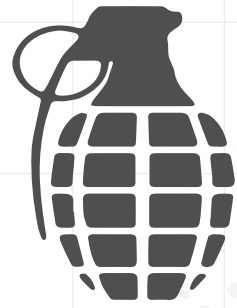

RPG-7 & RPG-9

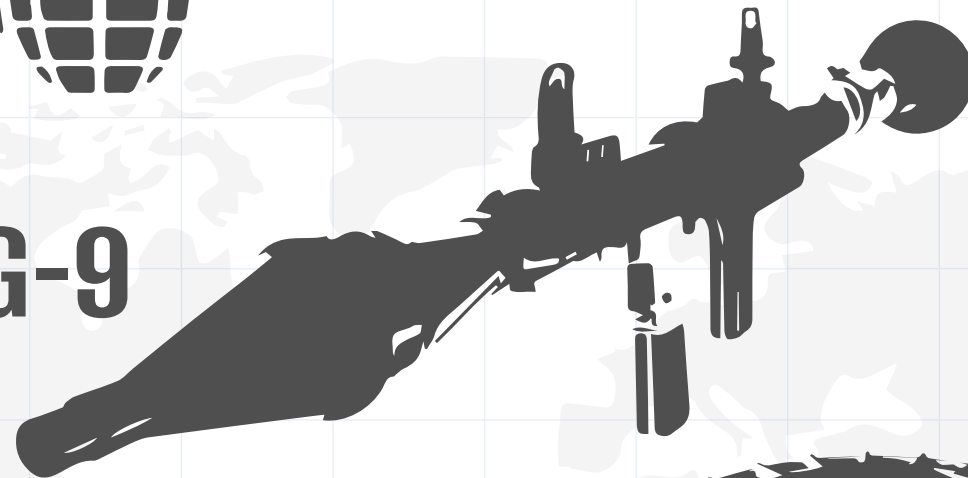

Anti-vehicle land mines

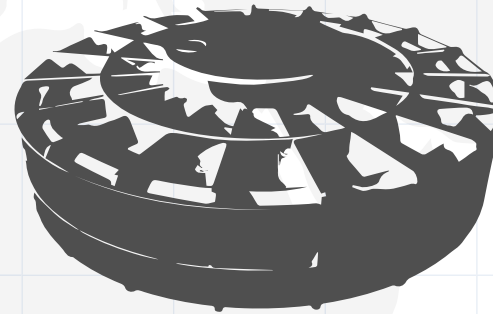

Shoulder-fired missiles



IEDs



WORLD ANTI EXTREMISM
NETWORK
BUILDING A FREE WORLD

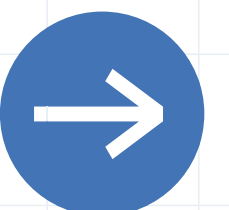

Support Items:

Ammunition

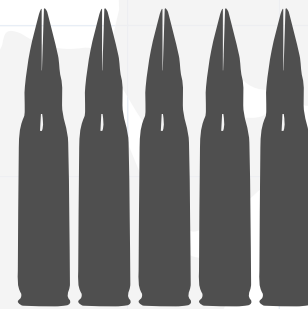

Rifle silencers

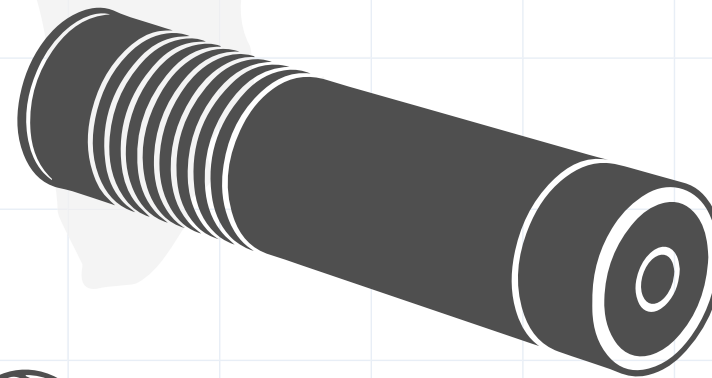

Rifle scopes

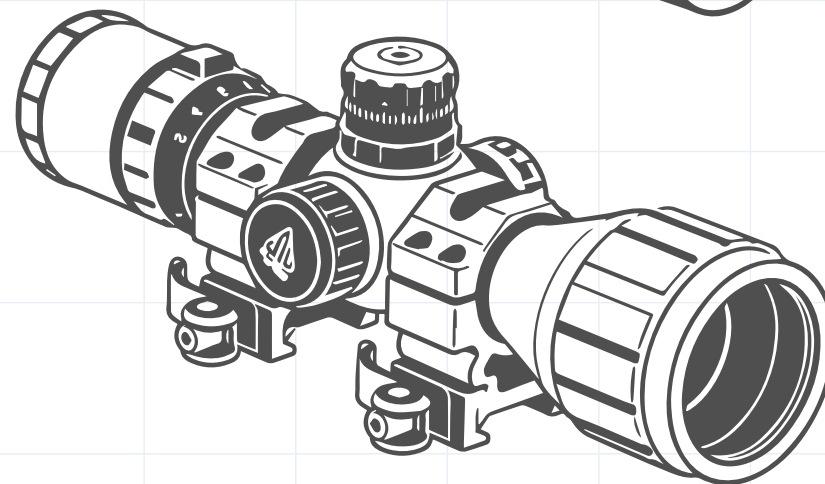

WORLD ANTI EXTREMISM
NETWORK
BUILDING A FREE WORLD

